

Design Considerations for a Minimally Invasive High-Throughput Automation System for Radiation Biodosimetry

A. Salerno^{*}, J. Zhang^{*}, A. Bhatla^{*}, O. V. Lyulko[#], J. Nie[†], A. Dutta[†], G. Garty[#],
N. Simaan^{*}, G. Randers-Pehrson[#], Y. L. Yao^{*} and D. J. Brenner[#]

Abstract—Design aspects of a minimally invasive high-throughput automation system for radiation biodosimetry are reported. The system, currently under development, relies on robotic devices and advanced high-speed automated image acquisition to perform mass triage following a radiological event. A design concept of the automation system is proposed based on the use of an input stage, a centrifuge module, a cell harvesting system, a liquid handling module, an imaging system and a service robot. The biological assays are described along with an analysis of the throughput requirements. The special requirements imposed by bioassay automation, system throughput and minimal invasiveness lead to the design of a custom-made multipurpose gripper and a cell harvesting module. Results on the embodiment design of these modules are provided. A prototype of the automation system is described.

I. INTRODUCTION

FOLLOWING a radiological event there will be a need for mass triage requiring analysis of tens to hundreds of thousands of samples. An example of this is the incident at Goiânia, Brazil [1] in 1987. In the first few days after the incident became known, about 130,000 people, out of the 1.3 million inhabitants of Goiânia arrived at screening locations and were monitored for radiation exposure. Only those showing both internal and external contamination were examined using biodosimetric techniques as existing systems for performing biodosimetric assays can handle at most a few hundred samples per machine.

The development of automated, high-throughput systems for biodosimetry has been declared top priority by the office of science and technology policy and the homeland security council [2].

During the last decade many engineers and scientists have teamed-up in the quest for designing automated systems for medical applications featuring higher and higher

throughputs. As a result several prototypes have been designed. Meldrum *et al.* have recently demonstrated a capillary-based fluid handling system, the ACAPELLA-5K (A5K), capable of processing genomic and chemical samples at a throughput of 5,000 preparations/8 hours [3]. Kachel *et al.* designed a custom-made automated system capable of isolating DNA plasmids at a rate of 1,600 plasmids/12 hours [4]. Prasanna *et al.* reported on the automation of cytogenetic biodosimetry featuring a throughput of 500 samples/week [5]. Soldatova *et al.* have commissioned a new robotic system for investigations of gene function in *S. cerevisiae* capable of initiating more than 1,000 experiments a day [6].

Several attempts have already been made to automate biodosimetric assays; however efforts were directed toward automating the imaging system rather than the biological processing itself. A rare exception to this is the work of [7] who attempted to automate the extraction of chromosomes from lymphocytes. The system throughput was, however lower than that of a skilled lab technician. Even so, throughputs are rather low, with each sample requiring several minutes or more for imaging alone, resulting in very low throughputs of a few tens to hundreds of samples per day.

This work deals with the design of a minimally invasive high-throughput automation system for radiation biodosimetry. The goal of this paper is twofold. First, an overview of the automation process, excluding the imaging system, is presented within the general context of the clinical requirements of the biodosimetry workstation. Second, a flexible automation system is presented with the relevant design considerations allowing the processing of 30,000 samples a day. This system is capable of process two distinct biological assays.

The paper is divided in six sections. In Section II an overview of the system is provided. A design concept of the automation system is proposed along with a description of the biological assays. Design and throughput requirements are then discussed. Section III analyzes the design challenges faced in achieving an embodiment of a multipurpose gripper while Section IV provides the reader with a detailed mechanical design of the cell-harvesting module. Finally, section V outlines the prototype.

II. SYSTEM OVERVIEW

The proposed automation system consists of several modules: input stage, centrifugation, cell-harvesting, liquid

This publication was supported by grant number U19 AI067773, the Center for High-Throughput Minimally Invasive Radiation Biodosimetry, from the National Institutes of Health / National Institute of Allergy and Infectious Diseases.

^{*} A. Salerno, J. Zhang, A. Bhatla, N. Simaan and Y. L. Yao are with the Department of Mechanical Engineering, Columbia University, New York, NY 10027 (as2948ljz2181lab2575lms2236lyly1@columbia.edu)

[#] O. V. Lyulko, G. Garty, G. Randers-Pehrson and D. J. Brenner are with the Radiological Research Accelerator Facility, Columbia University, Irvington, NY 10533 (ov1lgyg2101lgr6ldjb3@columbia.edu)

[†] J. Nie and A. Dutta are with the Center for Radiological Research, Columbia University, New York, NY 10032 (jn2244lad2352@columbia.edu)

handling, incubation and a high-speed, dedicated image acquisition system. Excluding the latter, an overview of the system is reported in Fig. 1.

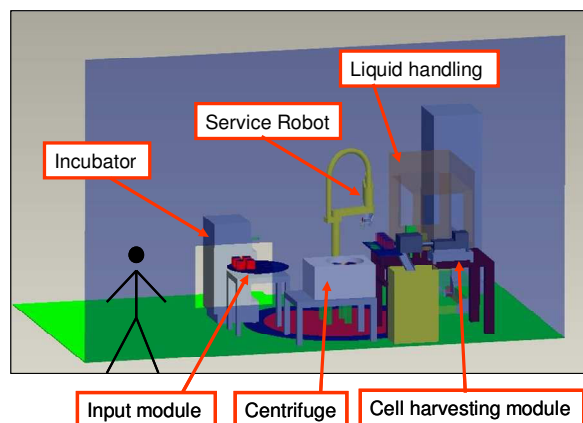

Fig. 1. Design concept of the automation system

The input stage is a FIFO stack for interfacing the human user and the automation system. The centrifuge module is needed to separate lymphocytes from red blood cells (RBC). The cell-harvesting module is responsible for imaging, triaging and isolating the lymphocyte band. The liquid handling module automates the biological assays for lymphocytes. The service robot transfers samples between modules using a multipurpose gripper.

A. Design Challenges

The automation system is designed in two phases. The phase 1 prototype aims to achieve a 6,000 samples/day throughput, while the phase 2 prototype is intended to meet a minimum throughput of 30,000 samples a day. In our design we require that these throughputs be achieved during an 18 hour duty cycle leaving six hours for any prescribed maintenance.

The system is minimally invasive. Blood samples are collected by a finger stick. The nominal volume of each sample is 50µl. Additionally, the system is designed to be: modular, portable, fully-autonomous and safe. The design for portability has been imposed by assigning approximately a 300cmx500cm footprint for the overall system, see Fig. 2.

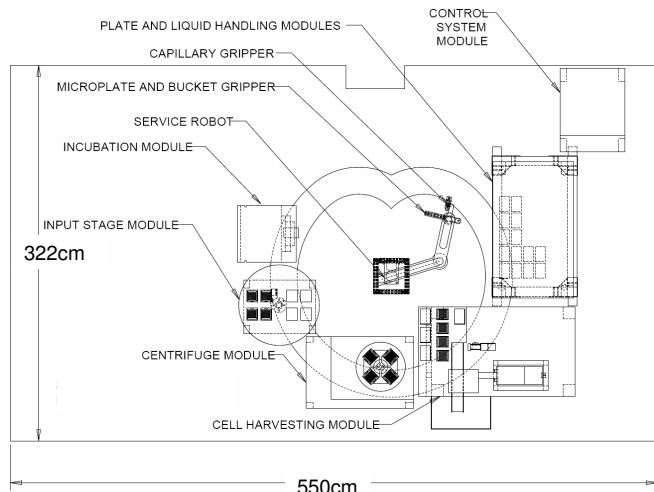

Fig. 2. System layout

This would allow the system to be truck transportable. The system has been supplied with utilities that are portable.

B. Sample Handling

The system is designed to process blood samples collected into bar-coded plastic capillary tubes at the emergency site using a finger stick. The capillaries are then transported in inserts to the biodosimetry workstation. After having been filled with inserts, see Fig. 3, the centrifuge buckets are loaded into the automation system by the operator through a safety barrier, see Fig. 1. At this point the buckets are handled by the robot gripper, see Fig. 3. Samples follow an unmanned series of operations that automate two different biological assays in order to assess the radiation exposure. The first assay is effective during the first 1-2 days, post irradiation, and the second at longer times, see next Subsection.

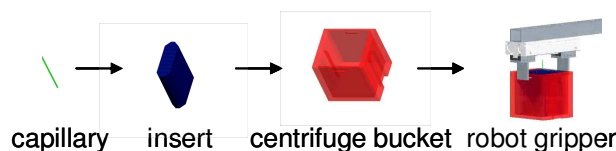

Fig. 3. System input

In Fig. 4 we report a block diagram of how the biological assays are automated.

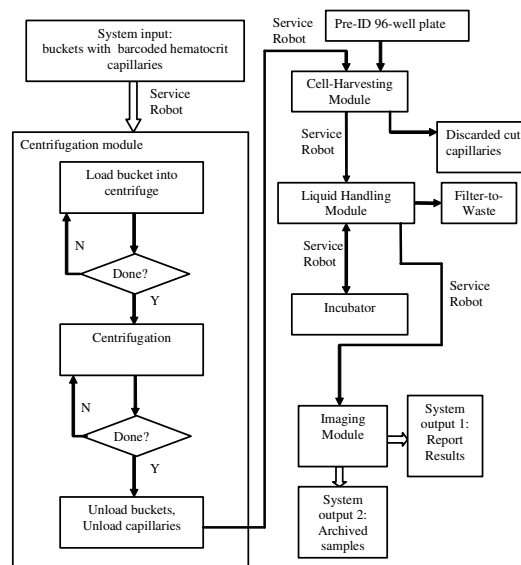

Fig. 4. Automation system - block diagram

The *blood samples* enter the automation system via an input stage. The service robot moves the centrifuge buckets from the input stage to the centrifugation module. After separation of white blood cells (WBC) and RBC, the centrifuged samples are transferred to the cell-harvesting module by the service robot using the bucket gripper. Using a capillary gripper that prevents the lymphocyte band from being disrupted, each capillary is removed from the insert and the samples are then identified one by one using a barcode-reader. Upon completion of the identification, the capillary is imaged by a CCD system in order to detect the separation layer between RBC and the rest of the sample. Then a laser system is triggered to cut the capillary thus

separating the sample into two parts one of which is disposed, namely the one with RBC. However, before performing the cut, the sample is imaged by the CCD system also for outputting an early assessment of radiation exposure. The thickness of the lymphocyte band is measured and an alarm signal is given in output if the value is low, see Fig. 5.

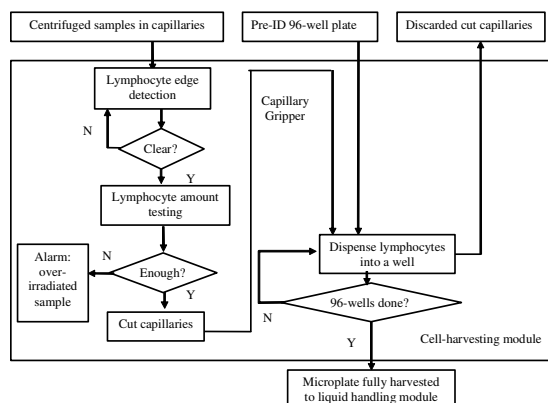

Fig. 5. Sample handling on the cell harvesting module

Each cut capillary, which contains now a sample of WBC of a single individual, is transferred to a specific well of an automation-compatible microplate by means of the capillary gripper which prevents the lymphocytes from falling under gravity, see Section III. The fully-harvested microplate, now containing the *lymphocyte samples* of 96 different individuals, is then transferred by the service robot onto the deck of a liquid handling module where the lymphocytes undergo to a series of washes and reagent addition. According to the type of biological assay used, the samples will be transferred to an incubator or a FIFO stacker, see Section IV. After having completed the biological assay, the filters of the microplates (to which the samples are attached) are imaged by a dedicated high-speed acquisition system and a report is produced summarizing the radiation exposure of a single individual, see next Subsection. The samples are then archived.

C. Selection of Biological Assays

Although the range of potential biodosimeters is rather extensive, most of them are inappropriate for high throughput automation due to their complexity or the difficulty to rapidly obtain samples [8, 9]. Out of the assays described in [8], two assays were chosen as being the most suitable for use in the robotic biodosimetry workstation: the micronucleus assay and the γ -H2AX assay.

Micronuclei in lymphocytes

Micronuclei are a well characterized endpoint for radiation dosimetry and the cytokinesis-blocked micronucleus assay [10] is recommended as a biodosimeter by the International Atomic Energy Agency [11]. They have also recently been shown to be a good predictor of cancer risk in humans [12]. Elevated micronucleus yields were also observed in exposed individuals following the incidents at Chernobyl [13] and Goiânia [14].

In this assay, see Fig. 6a, peripheral lymphocytes are separated from whole blood and stimulated to induce division. During division, the formation of cellular membrane is blocked resulting in binucleate cells.

Chromosomes damaged by ionizing radiation may lag in anaphase and will therefore not be included in the daughter nuclei during division and form a small separate “micronucleus”, as shown in Fig. 6b. The cells are then fixed and stained and can be automatically scored.

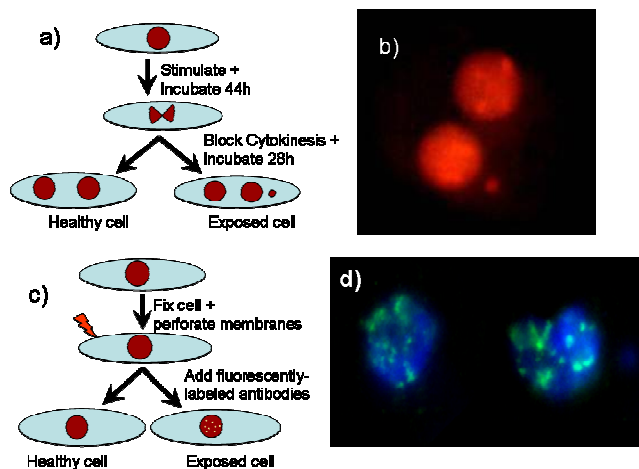

Fig. 6. a) Flow diagram of the micronucleus assay, fixation and staining omitted. b) Image of a binucleated cell with a micronucleus. c) Flow diagram of the γ -H2AX assay. d) Image of nuclei with multiple foci (following 2 Gy of X-rays).

The major advantage of the system is that the scoring of micronuclei in bi-nucleate cells virtually ensures that what is scored reflects damage to circulating lymphocytes, as opposed to the background level of micronuclei present in mono-nuclear lymphocytes. Thus the radiation specificity of the assay is excellent. This assay also has good dose coverage (at least 0.5 to 5 Gy), and the biomarker remains stable for months or even years post exposure [14]. A downside is that the lymphocytes need to be cultured, a process which takes about 72 hours during which the cells need to be kept at controlled temperature (37°C), CO₂ level (5%) and at high humidity. However, as we show, the process can be made fully automatic.

γ -H2AX foci in lymphocytes

The second assay is for detecting DNA double strand breaks (DSB) directly, by Phosphorylation of the histone H2AX (forming γ -H2AX) which occurs at DSB sites [15]. γ -H2AX can be tagged with a fluorescently labeled antibody, and can then be detected with excellent sensitivity using in-situ image analysis, as displayed in Figs. 6c, 6d. In that ionizing radiation is an efficient inducer of DSB, most of the early research on γ -H2AX has been done with ionizing radiation [16, 17].

Both DSB and thus γ -H2AX are formed linearly with dose from very low to extremely high (> 10 Gy) doses [16]. It has also been shown that exposure to 10⁻³Gy of X-rays, induces a significant elevation in H2AX Phosphorylation in human fibroblasts [18], making it more sensitive to low doses than the

micronucleus assay. No data have yet been published for γ -H2AX foci in human lymphocytes.

The γ -H2AX system well complements the micronucleus system as a radiation biodosimeter [19], requiring much shorter processing times as the cells do not have to be cultured 72 hours for the assay. Furthermore, the γ -H2AX foci reach their maximum value within about 30 minutes of irradiation [19], decaying over 24-36 hours post-exposure [20] this is contrasted with micronuclei that appear about 24 hours post-exposure and decay over months or years [14].

D. Throughput Requirements

The phase 1 prototype is currently under development and it is the focus of this paper. Nevertheless, we report also the phase 2 prototype specifications in this Subsection. The allowable centrifugation time is estimated for different sizes of the centrifugation batch, see Fig. 7. The phase 1 system features a 20-minute centrifugation at 40g with temperatures between 4 °C and 37 °C.

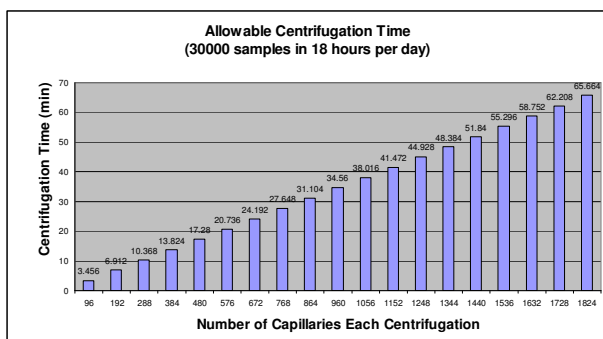

Fig. 7. Allowable centrifugation time.

The cell-harvesting and imaging module have been identified as the bottleneck of the system. These modules process samples individually while the rest of the biodosimetry components process several samples in parallel (e.g. 96, 384 and 576 samples).

The phase 2 system is designed to use a two-speed configuration protocol, equivalent to an 8-minute centrifugation at 40g followed by a 3-minute centrifugation at 160g. Sharp separation is obtained with the phase 1 centrifugation protocol, as shown in Fig. 8, while the phase 2 centrifugation protocol is currently being refined. As far as the remaining modules are concerned, the phase 1 system specifications impose a throughput of 10 sec/sample. However, the phase 2 system specifications assign a 2 sec/sample throughput. In order to verify that the current prototype, see Section V, would be compliant with the phase 2 system specification, throughput experiments were performed with the cell-harvesting module. Particular focus was given to the laser-based separation of lymphocytes from RBC. Experiments conducted with the current prototype resulted in a separation time of 2.5 seconds with a rotational speed of the capillary of 30 rpm and a laser power of 0.53 Watt. A design of experiments is undergoing for identifying the optimal parameters, namely rotational speed and laser power, which return a minimum separation time. The conceptual design, not reported here, of a multi-capillary

gripper capable of simultaneously gripping 24 capillaries at a time and of a gravity/back-fed capillary holder for the phase 2 system is also carried-out. Provision for the existing liquid handling module has been made in order to use a 384-position dispenser for the phase 2. For the phase 1 system a robotic incubator capable of simultaneously hosting 220 microplates has been selected: the STX220 from Liconic Inc.



Fig. 8. Centrifuged capillary showing red blood cells (RBC - bottom) and WBC band.

III. CENTRIFUGATION MODULE AND MULTI-PURPOSE GRIPPER

The design of the input stage is shown in Fig. 9a. This subsystem is responsible for moving four centrifuge buckets at the pick location of the service robot.

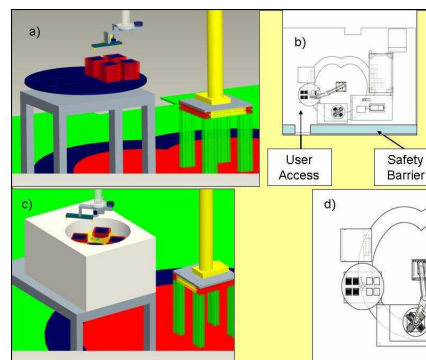

Fig. 9. Input stage: a) loading and b) safe user access. Centrifuge module: c) unloading and d) loading

In the current design, four centrifuge buckets are filled with three inserts, each carrying 48 capillaries, for a total batch of 576 capillaries per centrifugation cycle. When the centrifugation ends, the service robot transfers the empty centrifuge buckets back on the input stage after capillaries have been transferred to the cell-harvesting module. The input stage is also responsible for simultaneously *i*) moving the used centrifuge buckets (without capillaries) out of the system and *ii*) introducing a new set of centrifuge buckets (filled with capillaries) by performing a 180° rotation. This ensures continuity of the input to the automatic system. The input stage serves as a point of interface with the human user who is separated by the automation system by a safety wall, see Fig. 9b. The service robot is responsible for moving the buckets, one by one, from the input stage to the centrifuge module, see Figs. 9c-d. The reach of the service robot is augmented by a custom-made link endowed with a

multipurpose gripper capable of *i*) capillary handling and of *ii*) buckets and microplates handling. The capillary gripper is composed of a passive spring-plunger-collet unit and of an active gear-motor-shaft unit. The former is responsible for gripping the capillary without the use of any motor. The latter is responsible for the rotation of the capillary during cutting in order to guarantee an even distribution of the power, thus minimizing thermal effects and contamination generated by the laser-based cutting.

The bucket/microplate gripper is composed of a pneumatically-actuated two-jaw unit and two miniature photoelectric sensors, namely two QS18VN6FF100 from Banner Engineering Corp. Each jaw is composed of two sections: one for gripping the bucket and one for gripping the plate. The former is a custom-made jaw that seats into the side slots of the bucket when grip takes place. The latter is a rubber-padded jaw that grips microplates.

The centrifuge will be equipped with an electro-mechanical clutch that locks the rotor in place after it stops rotating. The optical sensors are in charge of detecting the centrifuge rotor arm. This operation guarantees a reference to the gripper when loading the buckets in the centrifuge. The gripper design, see Fig. 10, is modular and lightweight.

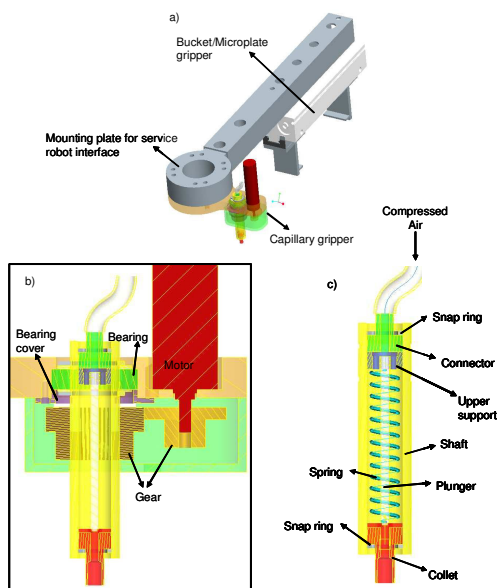

Fig. 10. a) Multipurpose gripper. b) capillary gripper and rotary stage. c) capillary gripper

The hollow structure allows for the passage of both pneumatic and electrical lines. The link length can be easily changed without having to change the mechanical interface with the robot. The two grippers, capillary and bucket/microplate, can be mounted independently on the service robot flange. Details on the design of the capillary gripper mechanism are reported in Fig. 10. When the capillary is gripped, the collet slides onto the capillary performing a vertical move thanks to the built-in linear actuator of the service robot. The gripping operation ends when the capillary comes into contact with the tip of the plunger. The latter prevents the lymphocytes to fall under

gravity after cutting the capillary. The plunger is also endowed with air-conductive channels that allow dispensing positive pressure for transferring lymphocytes into the microplate well after the capillary has been cut, i.e. after RBC have been removed.

IV. CELL-HARVESTING AND LIQUID HANDLING MODULES

After centrifugation, centrifuge buckets are transferred to the cell-harvesting module by the service robot using the bucket gripper. The cell-harvesting module is responsible for obtaining the lymphocytes from centrifuged blood samples, see Fig. 11.

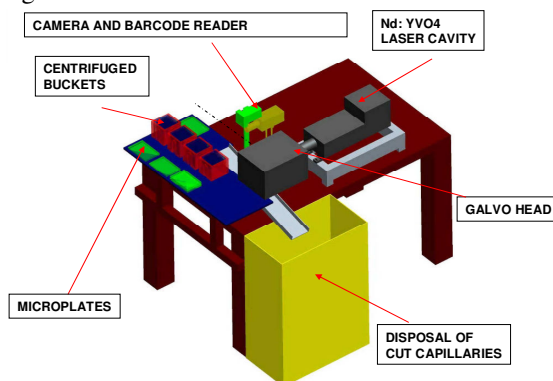

Fig. 11. Cell harvesting module

The cell-harvesting module consists of *i*) a laser system with a galvo head, *ii*) a barcode reader, a Hawkeye 1525 from RVSI, *iii*) a CCD camera, a CV-M4⁺CL from JAI (in combination with a frame grabber, a 1426 from National Instruments) for image segmentation, see Fig. 12, and *iv*) a custom-made holder for microplates and centrifuge buckets.

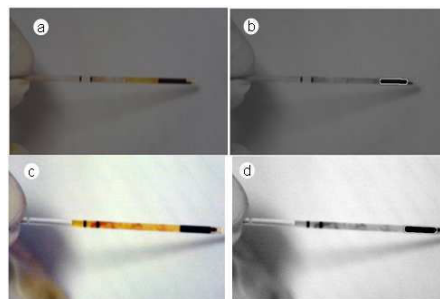

Fig. 12. Image segmentation of capillary. Note outline around RBC layer in b) and d).

The barcode reader identifies the capillary right before the CCD imaging. The barcoded capillaries have been registered at the collection site by using a commercial tracking and database system, like the EMTrack (patient tracking) by EMSYSTEM. The barcode reader allows tracking the sample after it has been transferred to a pre-id microplate. The holder hosts *i*) three microplate stacks, each made of 21 microplates, *ii*) four centrifuge buckets *iii*) a microplate reference location, where the wells are filled with lymphocytes *iv*) a gravity-based capillary disposal unit.

The inputs to the module are centrifuged capillaries in buckets and sterile automation-compliant microplates. The outputs of the system are cut capillaries, which are disposed, and microplates containing lymphocytes transferred from

capillaries. Two software-outputs are the data associated with *i*) the barcode-based identification of the capillaries and *ii*) the lymphocyte thickness estimation. The operation of the module follows a sequential routine outlined below.

The microplate gripper transfers a multi-well plate from the stack to the reference location. The capillary gripper is then deployed to service each capillary. The capillary is moved in the field of view of the barcode reader for identification. After reading, a vertical move is performed by the service robot and the capillary is moved in the field of view of a CCD camera for detection of the separation band between RBC and the rest of the sample. Upon detection of the band, the laser performs the cut while the capillary is rotated by the rotary stage of the gripper. During imaging, an estimation of the lymphocyte band thickness is also performed by using the same machine vision system. Upon cutting the capillary, the part containing RBC is disposed into a biohazard waste container by means of gravity, see Fig. 13. The cut capillary, containing lymphocytes and plasma, is moved above the well of the microplate in the reference location where lymphocytes are dispensed using the capillary gripper. The cut capillary is then disposed into a biohazard waste container. During this operation the service robot will move downward while the collet will move upward until the inner wall of the collet is in contact with the outer surface of the capillary. When the foregoing contact ends the capillary falls under gravity. The capillary will then be disposed into a biohazard waste container. Once a multi-well plate is fully harvested the service robot transfers it to the liquid handling module, see Fig. 14.

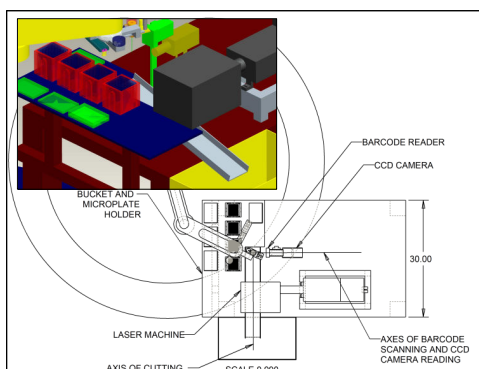

Fig. 13. Cell-harvesting module – detailed top view

The liquid handling module is responsible for the automation of both micronuclei and γ -H2AX assays for lymphocytes. This is accomplished by a sequence of washes and reagent addition. As the phase 1 system is designed for a throughput of 6,000 samples per day, using 96-well plates, and the assay duration is 72hr approximately, the incubator should be capable of storing at least 189 microplates simultaneously. To this effect the STX220 incubator is integrated with the liquid handling module as shown in Fig. 14. While running the micronucleus protocol, see Subsection II.C, the service robot places the microplate in the lower left position on the deck of the liquid handling robot. After a wash and the addition of culture medium the microplate is

transferred to the incubator. The microplate is then transferred back to the liquid handling robot for the addition of Cytochalasin-B. The microplate is then transferred into the incubator for the last incubation cycle. After the latter the protocol continues in the liquid handling module. In the case of γ -H2AX protocol, see Subsection II.C, the initial operation consists of moving the microplate to the lower left position of the liquid handling robot. After a wash and the addition of the permeabilization buffer, the microplate is transferred to a FIFO stacker for 20 minutes. The plate then moves back to the liquid-handling robot where blocking reagents are added. The microplate is then transferred back on to the FIFO stacker for other 30 minutes and then returns to the liquid-handling robot deck. Then the protocol continues on the liquid handling robot.

The fully-integrated liquid handling module is composed of a gantry system, an ultrasonic wash-station, a bulk-dispenser, a positive pressure unit, a filter-to-waste unit, a fixed-cannula array and a microplate gripper. The gantry system moves the microplate gripper, the fixed-cannula array (or the positive pressure unit) and the bulk dispenser at one of the specified microplate locations on the operation deck. The filter-to-waste unit collects the result of the well washes. The ultrasonic wash-station guarantees avoidance of reagent-mixing by washing the metallic fixed-cannula array tips before changing reagent. The microplate gripper moves the plates or/and their lids across the deck.

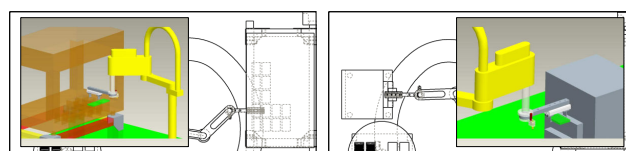

Fig. 14. Sample transfer from liquid handler to robotic incubator

V. PROTOTYPE

In order to develop the prototype, see Fig. 15, a room was selected in such a way to impose dimensional constraints that would increase system portability.

The automated biosimetry room is located in the Mudd Engineering building at Columbia University Morningside Campus within the Department of Mechanical Engineering. The biosimetry workstation features an RS80 from Staubli Inc., an O-Sprey UV laser system from Quantronix, a Sciclone ALH 3000 from Caliper Life Sciences Inc., a 5810RA centrifuge from Eppendorf AG and a main frame computer from iBASE Technology Inc. running the RTAI for Linux for the low level control.

The specific liquid handler was selected for the following characteristics that meet the biosimetry requirements: *i*) bulk reagent dispenser is capable of continuously dispensing 10-2,500 μ l of a single reagent simultaneously in eight wells with a coefficient of variation smaller than 2-3%, *ii*) fixed-cannula array guarantees the same coefficient of variation and it is capable of dispensing up to 25 μ l of a reagent simultaneously in 96 wells, *iii*) absence of disposable tips is

intentional in the design of the system¹. The foregoing SCARA robot was selected for its open architecture controller and for the +/-0.025mm repeatability, needed for the robotic-assisted laser-based cutting. The above-mentioned laser machine was chosen because the system is capable of barcoding and cutting plastic capillary tubes. Finally the specific centrifuge was selected because it meets the requirements of temperature control and throughput.

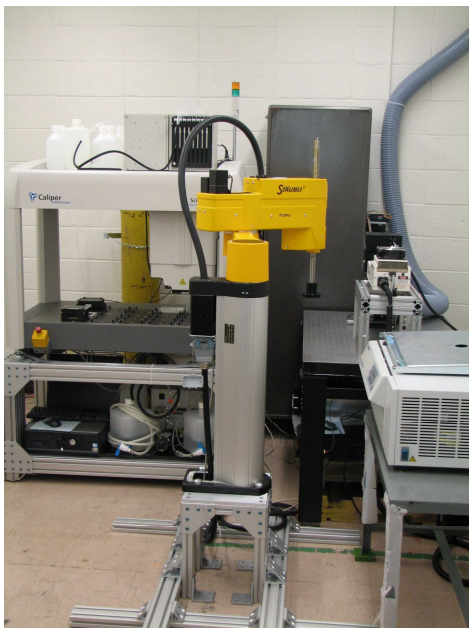

Fig. 15. Prototype

Several custom-made components have been designed, namely an automatic centrifuge brake and lid, two grippers (bucket and capillary), the input stage and cell harvesting sub-component fixtures and layout.

VI. CONCLUSION

This paper presented an overview of an ongoing project on developing a novel high throughput automation system for radiation biodosimetry. The driving clinical needs, the alternatives for processing the incoming blood samples using γ -H2AX or micronuclei assays, and the corresponding automation cycles for a single incoming micro-pipette were detailed. The key robotic components of this automation system were presented together with custom designed multipurpose grippers and a novel cell harvesting module. The grippers were designed to accept micro-pipettes, centrifuge buckets, and microplates. The cell-harvesting module was designed to harvest the lymphocytes from a centrifuged micro-pipette while using vision algorithms to segment the lymphocyte layer and to detect low lymphocyte volumes in patient samples that require triage. The cell-harvesting module also included a laser machine for contactless cutting of micropipettes.

¹ Relying on this type of consumables would strongly hamper the use in an emergency condition of the system. The use of metallic tips makes the system operation independent from the availability of disposable tips.

Although this paper is focused on automation for high throughput biodosimetry, we believe that the system at hand is relevant to many automation systems geared towards high throughput handling of blood samples. As a matter of fact the biodosimetry workstation can be used in the γ -H2AX configuration with modified reagents for detecting the presence and inter-cell distribution of other proteins and can therefore be used for mass screening of various diseases such as cancer, HIV or Hepatitis.

REFERENCES

- [1] International Atomic Energy Agency, *The radiological accident at Goiânia*, ed. I.A.E.A. 1988, Vienna.
- [2] T.C. Pellmar and S. Rockwell, *Priority list of research areas for radiological nuclear threat countermeasures*. Radiation Research, 2005. **163**: p. 115-123.
- [3] Meldrum, D.R., et al., *Sample Preparation in Glass Capillaries for High-Throughput Biochemical Analyses*, in *International Conference on Automation Science and Engineering*. 2005: Edmonton, Canada.
- [4] V. Kachel, G.Sindelar, and S. Grimm, *High-throughput isolation of ultra-pure plasmid DNA by a robotic system*. BMC Biotechnology, 2006. **6**(9).
- [5] Prasanna, P.G.S., et al., *Cytogenetic Biodosimetry for Radiation Disasters: Recent Advances*. 2005, Technical Report. (AFRRI CD 05-2). Armed Forces Radiobiology Research Institute.
- [6] Soldatova, L.N., et al., *An ontology for a robot scientist*. Bioinformatics, 2006. **22**(14): p. 464-471.
- [7] Hayata, I., et al., *Robot system for preparing lymphocyte chromosome*. J. Radiation Research, 1992. **33**(Supplement): p. 231-241.
- [8] Amundson, S.A., et al., *Biological indicators for the identification of ionizing radiation exposure in humans*. Expert Rev. Mol. Diagn., 2001. **1**: p. 211-219.
- [9] Durante, M., *Potential applications of biomarkers of radiation exposure in nuclear terrorism events*. Physica Medica, 2003. **XIX**(3): p. 191-212.
- [10] M. Fenech and A.A. Morley, *Measurement of Micronuclei in Lymphocytes*. Mutation Research, 1985. **147**(1-2): p. 29-36.
- [11] International Atomic Energy Agency, *Cytogenetic analysis for radiation dose assessment : a manual*, ed. I.A.E.A. 2001, Vienna. 127 p.
- [12] Bonassi, S., et al., *An increased micronucleus frequency in peripheral blood lymphocytes predicts the risk of cancer in humans*. Carcinogenesis, 2007. **28**(3): p. 625-631.
- [13] Livingston, G.K., et al., *Radiobiological evaluation of immigrants from the vicinity of Chernobyl*. International Journal of Radiation Biology, 1997. **72**: p. 703-713.
- [14] da Cruz, A.D., et al., *Human micronucleus counts are correlated with age, smoking and cesium-137 dose in the Goiânia (Brazil) radiological accident*. Mutation Research, 1994(313): p. 57-68.
- [15] Rogakou, E.P., et al., *DNA Double-stranded Breaks Induce Histone H2AX Phosphorylation on Serine 139*. J. Biol. Chem., 1998. **273**(10): p. 5858-5868.
- [16] MacPhail, S., et al., *Expression of phosphorylated histone H2AX in cultured cell lines following exposure to X-rays*. International Journal of Radiation Biology, 2003. **79**(5): p. 351-358.
- [17] Rogakou, E.P., et al., *Megabase chromatin domains involved in DNA double-strand breaks in vivo*. J. Cell Biol., 1999. **146**: p. 905-916.
- [18] K. Rothkamm and M. Lobrich, *Evidence for a lack of DNA double-strand break repair in human cells exposed to very low X-ray doses*. Proc. Natl. Acad. Sci. USA, 2003. **100**: p. 5057-5062.
- [19] Pilch, D.R., et al., *Characteristics of gamma-H2AX foci at DNA double strand breaks sites*. Biochemistry and cell biology, 2003. **81**(3): p. 123-129.
- [20] J. P. Banath, S. H. Macphail, and P.L. Olive, *Radiation sensitivity, H2AX phosphorylation, and kinetics of repair of DNA strand breaks in irradiated cervical cancer cell lines*. Cancer Research, 2004. **64**: p. 7144-7149.